

# DECKING

taken one  
step further

Outdoor living,  
outdoor is megawood.<sup>®</sup>

*Linden*hof

**NEW**

**LIMES** fencing system

Pages 40-46

Experience the terrace  
at home

Pages 12-15



## The megawood® magazine

04-05 Trust made in Germany  
06-07 Good reasons for megawood®

---

08-21 **Experiencing Decking projects**

---

22-23 Interactive megawood®  
24-25 Colour diversity and colour maturation

---

26-35 **Our Decking range**  
36-37 Fix Step sub-construction  
38-39 Product overview Decking  
40-43 **LIMES fencing system** **NEW**  
44-45 Construction wood range  
46-47 Product overview LIMES

# "Wood... taken one step further"



**Thinking one step further** – You can learn what this motto means to us on the following pages. In doing so, we will focus on three locations. Get inspired by the stories, photos and videos as well as the people behind them.

megawood® barefootboards are exclusively manufactured in Germany. Our products are globally unique. They consist of up to 75% natural fibres from the wood planing and sawmill industries and originate from sustainably managed timber stocks. We refine them with 25% polymers and additives.

Wood is good and we make it even better. We utilise the positive attributes and supplement them with further advantages. megawood® can be recycled and can be returned to the production process. The raw material of today is also the raw material of tomorrow. This is our contribution for the benefit our children and grandchildren.

Dipl.-Ing. Holger Sasse  
Managing Director



You can find more information regarding the philosophy of megawood® via the adjacent QR code or at [www.megawood.com/101](http://www.megawood.com/101)



# Trust – Made in Germany

"Chips are created wherever wood planing takes place" – and this is great news!

Sawmill and wood planing chips: They are our basis for the raw material of tomorrow. At our Company Headquarters in the central German town of Aschersleben, we further develop and process them into an innovative wood-polymer material. Over 125 employees working for our company group have manufactured over **6 million square metres** of decking floorboards **since 2005**. This volume of assembled surfaces is our guarantee to you. We are the European market leader and we want to keep it this way. Therefore, we have patented our knowledge.

The name: **megawood®**. It combines wood as a natural product with an innovative polymer technology to create a unique environmentally-friendly and recyclable natural material which is the basis for our products. The **solid structure** of our floorboards guarantees durability and dimensional stability. This is the decisive difference compared to hollow section products! Furthermore, we comply with all applicable standards and the legal warranty requirements.

## Child safety included

We rely on nature: Our wood material consisting of up to 75% of natural fibres is **free from softeners and PVC**. This makes a great impression: We have already obtained official approval for the manufacture of toys.

## Practice makes perfect

We regularly offer training courses for tradespeople, dealers, and assembly facilities at our Lindenhof Training Centre. Consequently, our certified megawood® partners are always up-to-date in terms of technology. Together with the VHI (German Association of the Wood-Based Materials Industry), we are committed to sustainable construction using wood polymer materials at the "Institut Bauen und Umwelt" (German Construction and Environment Institute).

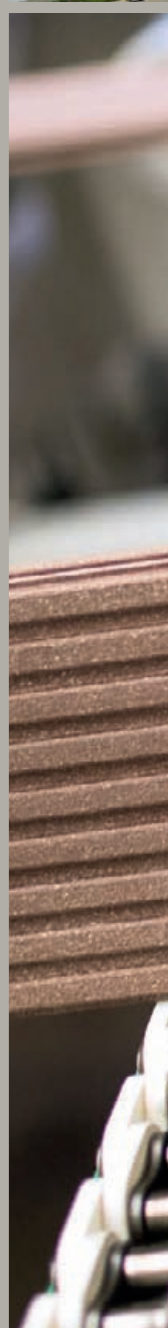





made in Germany  
**megawood**

The NOVO-TECH company headquarters  
in Aschersleben, Saxony-Anhalt



Aschersleben



Experienced trained employees examine  
all products before they are placed on the  
market.



# The advantages are obvious



You can find more good reasons as well as answers from megawood® via the adjacent QR code or at [www.megawood.com/102](http://www.megawood.com/102)



# Good reasons for a megawood® deck

## The best of both worlds

megawood® barefootboards combine the positive attributes of wood with knowledge from the field of modern polymer research. What is the result? A natural surface: From a textured profile to a colour effect signed by nature, megawood® barefootboards are **more resistant than wood** and are extremely durable. They can be processed just as easily as wood and create a **unique barefoot feeling**. The visual appearance, feel, and smell of wood as a

natural material remain intact but the laborious maintenance such as regular oiling or painting is no longer required. The deckboards do not even become grey like wood, even when exposed to UV rays. And all of this is achieved without a single plastic layer.

We only manufacture solid barefootboards from megawood® products – we do not manufacture susceptible hollow section floorboards. This keeps insects and penetrating water at bay. Our products comply with the highest health and safety requirements. As **no dangerous splinters** are to be found in our material, it is particularly suitable for barefoot use. In conjunction with Fix Step, our in-house sub-construction system, we offer a complete terrace system that is supplemented by the megalite LED light system and the megawood® privacy shield.

- **Solid Deck Boards**  
no hollow sections
- **Surface hardness**  
extremely resistant to scratches
- **Slip-resistant**  
even in the event of wet surfaces
- **Brushed surface**  
no plastic skin
- **Our own sub-construction**  
simple to handle and quick to lay
- **Colour fast**  
no greying as with wood
- **Durable**  
no coating required to make it last
- **Unique surfaces**  
naturally textured

# In harmony with nature



CLASSIC Jumbo barefootboard,  
Nut brown, open gap





made in Germany

**megawood**



You can find more information about the  
Gentian hut via the adjacent QR code or at  
[www.megawood.com/103](http://www.megawood.com/103)

# "High-tech for extreme weather conditions"

Daniel and Ines Schwegler have realised a dream by converting their mountain guesthouse in the Allgäu Alps. What was particularly important to the hostess of the Gentian hut when selecting the terrace material?

"The weather conditions are extremely rough for months on end here, at a height of 1,800 m and these conditions usually strain all materials", says Ines Schwegler with a sly smile on her face. But not megawood®. "Despite **extreme weather conditions** that continued through into May in some instances, our terrace still looks the same as it did shortly after our inauguration celebration." The large megawood®

**CLASSIC terrace** laid in 2012 has proven itself despite a permanent fluctuation between rain and sunshine as well as 35,000 hikers that have stopped at the hut in the meantime.

**The Gentian hut is passed on from generation to generation. The Schwegler Family thinks in large time dimensions.**

"Nature is the most valuable commodity that we must protect on behalf of our grandchildren", says Ines Schwegler. Therefore, the fact that no tree was cut down for megawood® particularly pleases her – also because of and, in fact, especially because of the unspoiled nature that her guests can enjoy from her terrace with a clear conscience.



**There is so much more potential in megawood®. The comfortable terrace is only the beginning.**

Once megawood® – forever megawood®? The answer is obvious to Ines Schwegler. "The material is so robust and diverse that I would love to buy megawood® blinds, balcony rails or furniture – immediately if I could!" This is because the constant maintenance and replacement of the pure wood elements at the mountain guesthouse take up a lot of time. Time that she would rather give to her guests that brave the climb to the hut each year. **The safety and comfort** of the hikers is Ines Schwegler's priority. "There is simply nothing better than a relaxing barefoot feeling following a demanding day of hiking, right?"







made in Germany  
**megawood**



**Ines Schwegler**  
Owner of the Gentian hut



**Daniel Schwegler**  
Owner of the Gentian hut



# More space on the terrace



**Pure beauty:** In addition to the **textured surface**, the new **SIGNUM barefootboard** (illustrated version: Tonka, open gap) from megawood® displays a **unique signature grain** in each floorboard which follows the natural course of solid wood structures.





made in Germany

**megawood**



Gain more impressions  
of megawood® at  
[www.megawood.com/125](http://www.megawood.com/125)

# "Family fun on the new terrace!"

Tino Früchtl – a family father is convinced that “I know what it involves!”.

Tino Früchtl, and a megawood® employee since 2009, fulfilled his desire for a megawood® deck during this year’s terrace season. As a long-standing co-creator of the material, he has a precise knowledge of the percentage of raw materials that go into the boards. “megawood® is produced using modern methods and has to pass extreme laboratory tests on a regular basis – this means that the demands I place on the new terrace are more than exceeded. I can confirm this at first hand“, says

Früchtl. Two aspects were especially important to the family father: the naturalness and the safety of the material. megawood® boards have a very near-natural surface and feel like wood. They do not however have any dangerous splinters, are colour-resistant and even non-slip when they are wet. The material is even approved for the manufacturing of toys – “It is therefore absolutely safe for our two children and for the four-legged family members“.

After the Früchtl family had converted and designed the house and garden themselves, the decision to also plan and lay the new terrace themselves was quickly made. “The planning with the terrace planner was much easier than we thought“. Seeing how the terrace would look in our garden in a virtual form in advance, was great fun“, says Linda Früchtl a bit proud. “It was also easy to construct with the assistance of the planner and the construction plan. I had even more fun with the decorating of the new terrace“, she says and returns to her family who are sitting on their new megawood® family terrace with friends on a mild summer’s evening for a cozy barbecue.

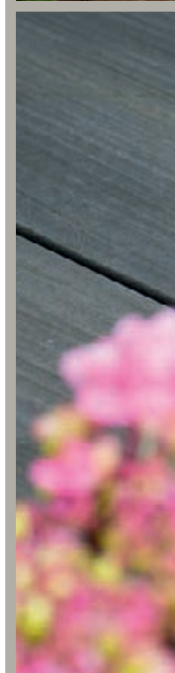
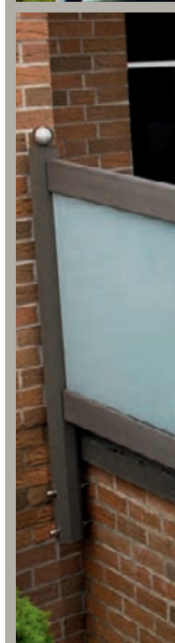





Made in Germany

**megawood**



Fencing elements made from megawood® construction planks



Früchtl family – proud megawood® terrace owners



Additional megawood® products  
Plant pots and sandpit



# Lindenhof – Inspiration for your home



**Pure beauty:** In addition to the **textured surface**, the new **SIGNUM barefootboard** (illustrated version: Muskat, open gap) from megawood® displays a **unique signature grain** in each floorboard which follows the natural course of solid wood structures.





made in Germany

**megawood**



Experience more future visions  
from megawood® at  
[www.megawood.com/105](http://www.megawood.com/105)



# "Enjoy special moments outdoors"

Innovation means to fully focus on progress. For Armin Junghanns, Head of Application Engineering at megawood®, this is his mission in life.

He enthusiastically shows us around the rooms of the Lindenhof in Aschersleben. He constantly points out many objects that have already been manufactured from megawood® as single pieces or in small production runs. "The opportunities are almost limitless. The material combines the **naturalness of wood** with the resistance and flexibility of polymers", says Mr Junghanns. The furniture at Lindenhof, which doubles up as an inspiring training centre for stockists and installers, also proves that a board does not always have to be square. Anything goes. Lindenhof provides a **window to the near future** – Armin Junghanns collects it and further develops it. His ideas are subjected to the acid test of everyday life at Lindenhof. "A product will only be available for you to enjoy at home once we are 100% satisfied with it." He also promises this in terms of the ecological aspect of the material and adds "**no tree will be cut down for us!**"

## Home comfort

In addition to the raised garden beds, facades and fences, it goes without saying that Lindenhof also boasts the most diverse of barefootboards. The **SIGNUM** deck is a real eye catcher. The residents of the small village like sitting there on the megawood® benches in order to enjoy the evening Sun. "The surface structure of the floorboards really come into its own thanks to the alternating light and shade", explains Armin Junghanns who is already looking forward to a cosy family evening on his megawood® deck.



You can find innovative applications via the adjacent QR code or at [www.megawood.com/106](http://www.megawood.com/106)

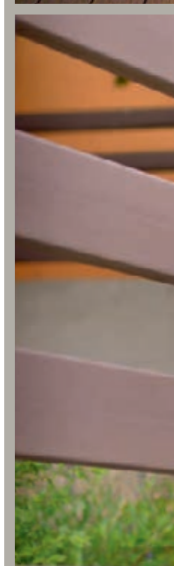
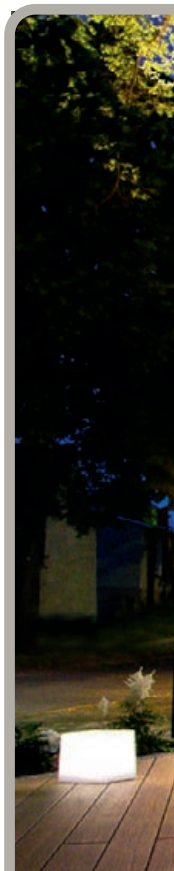





made in Germany

**megawood**

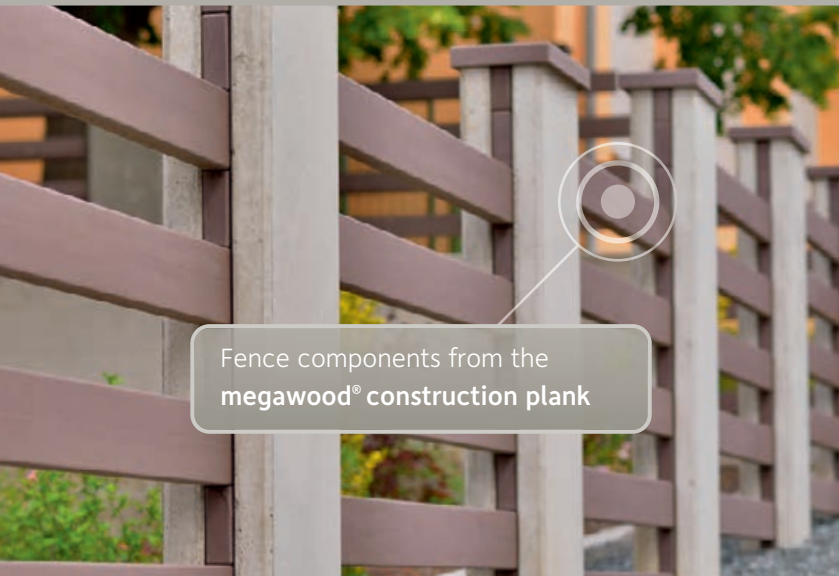

Fence components from the megawood® construction plank



**Armin Junghanns**  
Head of Application Engineering





# "Deck construction with expertise"

"I can install that with a clear conscience."

This sentence is always uttered whenever master craftsman Thomas O. Kling speaks to his customers about the solid megawood® deck boards that are consistently manufactured from unpainted wood-polymer material. "The boards retain their shape, they don't bend as water cannot penetrate solid floorboards and cause frost damage as can happen on hollow section floorboards." For some years now, TOK from Munich has utilised megawood® – the only material on the market with a wood content above 70%. **"That is exactly what my customers want.** No imported floorboards that are coated in plastic." megawood® is a real wood product manufactured from **certified, sustainable forests** that, thanks to its brushing, also visually **emphasises the natural character** and is also **robust**. "Ultimately, the deck should continue to look great for years to come."

## A complete decking system

Whether a party zone or a quiet area: "Enjoying your own deck can happen particularly quickly if the substructure is suitable", says Mr Kling. He is referring to the **sophisticated FIX STEP construction system**. "The boards can be quickly laid: simply adjust the height, click the beam in and then lock the boards in place with the **'Zammer'** so that they are invisible." As an experienced craftsman, he is able to quickly lay decks in this way and almost without the need for any screws.

## Manufactured internally and externally from megawood® – completely homogeneous

Kling believes that the development of the surfaces is a natural process that even "digests" red wine stains after a few weeks of sunlight. "I am happy to make this promise to my customers." With megawood®, most traces of use disappear after a few weeks by themselves thanks to natural processes. "Wood simply isn't plastic! In nature, nothing remains as it is. Nature is alive and this is how it should be."

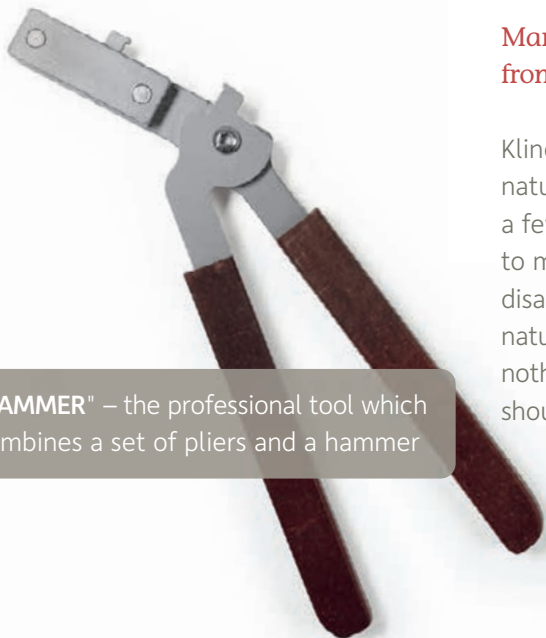

"ZAMMER" – the professional tool which combines a set of pliers and a hammer





made in Germany

**megawood**

"It's fun to install a sophisticated system."



Master craftsman  
Thomas O. Kling

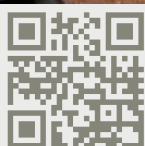

You can find more construction tips via the the adjacent QR code or at [www.megawood.com/107](http://www.megawood.com/107)



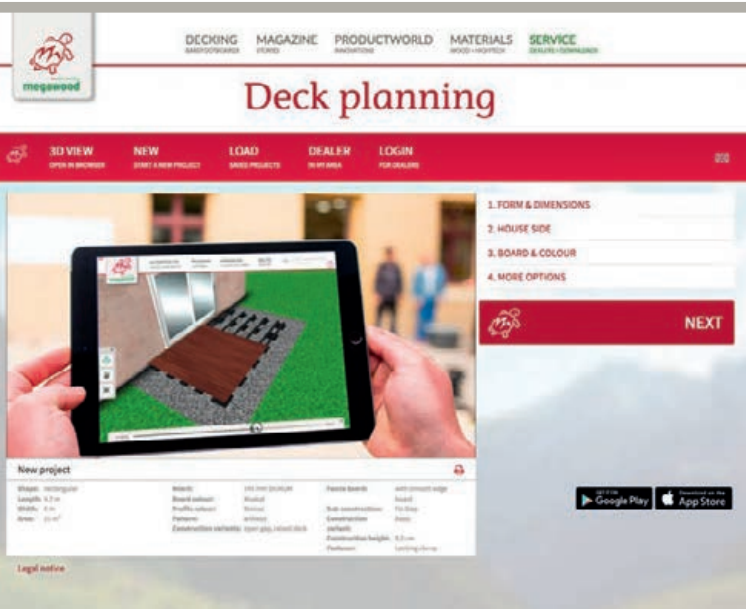

1

1

The playground prior to construction of the new SIGNUM deck.

2

Digital planning of the deck in front of the Luisenschule using the megaplanner<sup>3d</sup>.

3

Completed SIGNUM deck at the Luisenschule.



2

3



You can find the deck planner and the download link for the megawood® 3D-App via this QR code or at: [www.megawood.com/108](http://www.megawood.com/108)





# Deck planning via tablet & PC

## **megaplanner<sup>3d</sup> online**

Anyone who prefers to plan using their computer instead of pencil and paper should take a look at our online **megaplanner**. Digital is simply better and, above all, easier! The planner accurately masters all megawood® construction rules and generates a **3D view** of the planned deck down to the last millimetre. Each one of your projects receives an individual **planning number** which you can use to obtain a tailored quote from your dealer in person. You can also easily locate your dealer as we have equipped our **megaplanner** with a fairly clever **dealer search** option complete with contact details.

## **Virtual reality**

When using the unique **megawood® App** for iOS and Android, you can then virtually lay your planned terrace in front of your house. Simply put the **marker photo** from the reverse side of the brochure to the house wall and focus on it using the camera. Your virtual deck will now appear in the live screen of your tablet or Smartphone exactly at the marker point. From the sub-construction to the barefootboard, all details can be viewed from close proximity and from all directions. Although we have not yet invented a button that allows the virtual deck to be constructed immediately in your garden, we are working on it. Until then, your dealer is looking forward to receiving your request. Don't forget your planning number!







Construction plank  
in lava brown

PREMIUM PLUS barefootboard  
Slate grey, open gap

**Natural colour diversity:**

 NATURAL BROWN 	 NUT BROWN 	 BASALT GREY 	 LAVA BROWN 	 SLATE GREY 
 MUSKAT 	 TONKA 	 CARDAMOM 	 NIGELLA 	





# Colour diversity and colour fixing

The diverse colour range of the megawood® barefootboard is based upon natural colour tones and consequently fits in harmoniously with the individual conditions of your garden. Look forward to a deck that will become more characteristic over time. Up to 75% of the megawood® barefootboard is made up of natural fibres. The colour effect of the product will continue to change and will obtain its final, natural and permanent colour after a few months depending upon exposure to direct sunlight.



You can find further information in the construction plan and via the adjacent QR code: [www.megawood.com/109](http://www.megawood.com/109)



# CLASSIC but not ordinary

No matter how you rotate and turn it, our **CLASSIC barefootboards** simply fit in everywhere. The megawood® combination deck board profile allows the boards to be laid on both sides – either with a **reeded** or **grooved** surface. Our **megawood® solid deck boards** are flexible and are suitable for all applications.

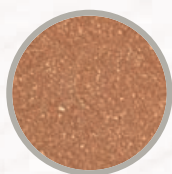

NATURAL BROWN

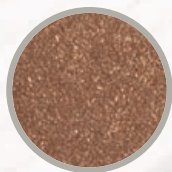

NUT BROWN

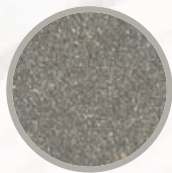

BASALT GREY

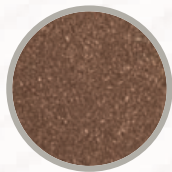

LAVA BROWN

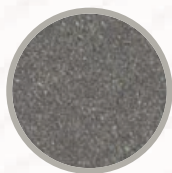

SLATE GREY



## CLASSIC BAREFOOTBOARD

**Surface:** Combination floorboard, reeded surface, grooved underside.  
The tried-and-trusted classic for the decking.





made in Germany

**megawood**

CLASSIC barefootboard,  
Nut brown, open gap



You can find application examples  
via the adjacent QR code or at  
[www.megawood.com/110](http://www.megawood.com/110)



# SIGNUM – Guaranteed to be unique

The megawood® **SIGNUM barefootboards** are "**signed by nature**". In addition to the textured surface, each barefootboard boasts a unique refined grain. But that's not enough. We also apply a polish to the surface as an initial protection for transport, laying and the first few weeks of use. This polish wears away over time and the floorboard develops its own natural patina through the impacts of weathering. This creates a refined and premium product: The grain and refinement ensure that the SIGNUM is a robust beauty and that each deck is an eyecatcher! The **narrower gap** ensures a seamless deck appearance.



## SIGNUM BAREFOOTBOARD

**Surface:** Single-sided, textured, polished surface, 5 mm gap



SIGNUM barefootboard,  
Muskat, open gap



made in Germany

**megawood**



You can find application examples  
via the adjacent QR code or at  
[www.megawood.com/111](http://www.megawood.com/111)



# PREMIUM – natural Planed surface

As unique as nature itself: The **individually planed** floorboard surfaces of our megawood® **PREMIUM barefootboards**. They obtain their lively structure in a patented planing process which makes our product unique. Discover this particular surface structure in interaction with light.

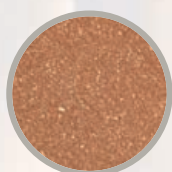

NATURAL BROWN

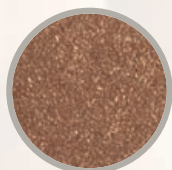

NUT BROWN

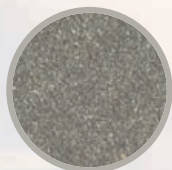

BASALT GREY



## PREMIUM BAREFOOTBOARD

**Surface:** Textured-planed, surface, brushed underside.

As unique as nature itself: the individually structured PREMIUM surface.





Made in Germany

**megawood**

**PREMIUM barefootboard,**  
Nut brown, closed gap



You can find application examples  
via the adjacent QR code or at  
[www.megawood.com/112](http://www.megawood.com/112)



# PREMIUM PLUS – top-quality

Too refined for outside? As if! The megawood® **PREMIUM PLUS** barefootboards are a top-quality product. This is where **unique specimens** meet volume production: The uniqueness of the **planed floorboard surface** is combined with the advantages of the **finest surface structure** in dark, refined colours.



LAVA BROWN

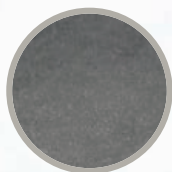

SLATE GREY

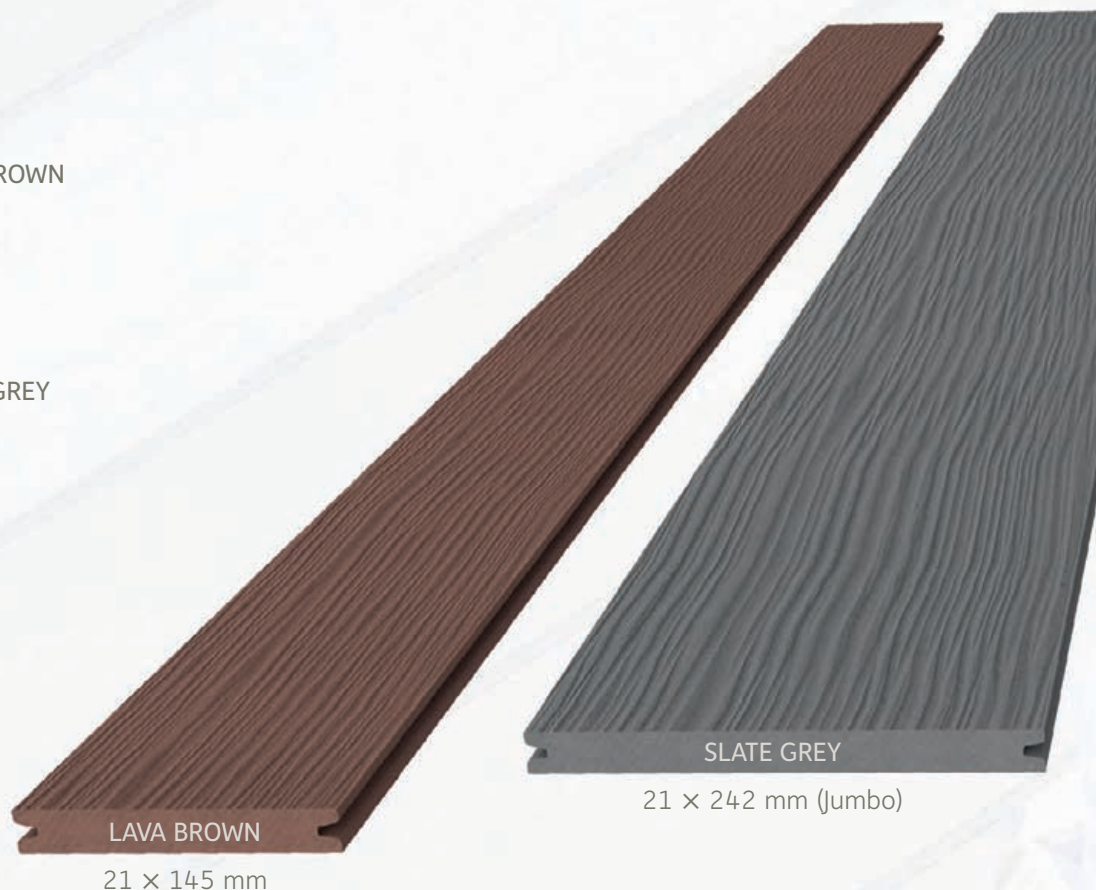

LAVA BROWN

21 × 145 mm

SLATE GREY

21 × 242 mm (Jumbo)

## PREMIUM PLUS BAREFOOTBOARD

**Surface:** Textured-planed, surface, brushed underside



PREMIUM PLUS barefootboard,  
slate grey, closed gap



made in Germany

**megawood**



You can find application examples  
via the adjacent QR code or at  
[www.megawood.com/113](http://www.megawood.com/113)



# DYNUM – durably attractive

Dynamically windswept dunes from the Sahara desert inspired us to create a floorboard with a **unique look**. Allow yourself to be amazed by the **DYNUM barefootboard** on your deck and experience the fascinating radiance under varying incidence of light.

DYNUM is the right choice for your most beautiful space in the garden as well as for hotel, beer garden or other commercial projects.

The **homogeneous and inspired wood material** without any additional plastic layer is able to withstand the highest of stresses and is particularly durable.



CARDAMOM



NIGELLA



## DYNUM BAREFOOTBOARD

**Surface:** Textured on one side, oscillating brushed surface, 5 mm gap

**Special feature:** Polish for initial protection, durable, robust





made in Germany

**megawood**

**DYNUM barefootboard,**  
Nigella, open gap



You can find application examples  
via the adjacent QR code or at  
[www.megawood.com/114](http://www.megawood.com/114)



# FIX STEP System – our flexible sub-construction

With the megawood® FIX STEP System, we offer you a continuous and sophisticated system from the clickable construction beams to the locking clamp. This system is characterised by **simple handling** and **fast laying**. Time-consuming preparation work tasks such as predrilling in concrete are now a thing of the past. Your megawood® construction plan will tell you just how this can be done.

With the megawood® FIX STEP System, you have chosen the easiest way to lay your deck, irrespective of whether you want an open or closed gap. Thanks to its lightness, the FIX STEP is also suitable for a floating laying style on roof terraces. And with the **variable height adjustment**, even existing, or uneven paved area are perfectly built over in the shortest of times.

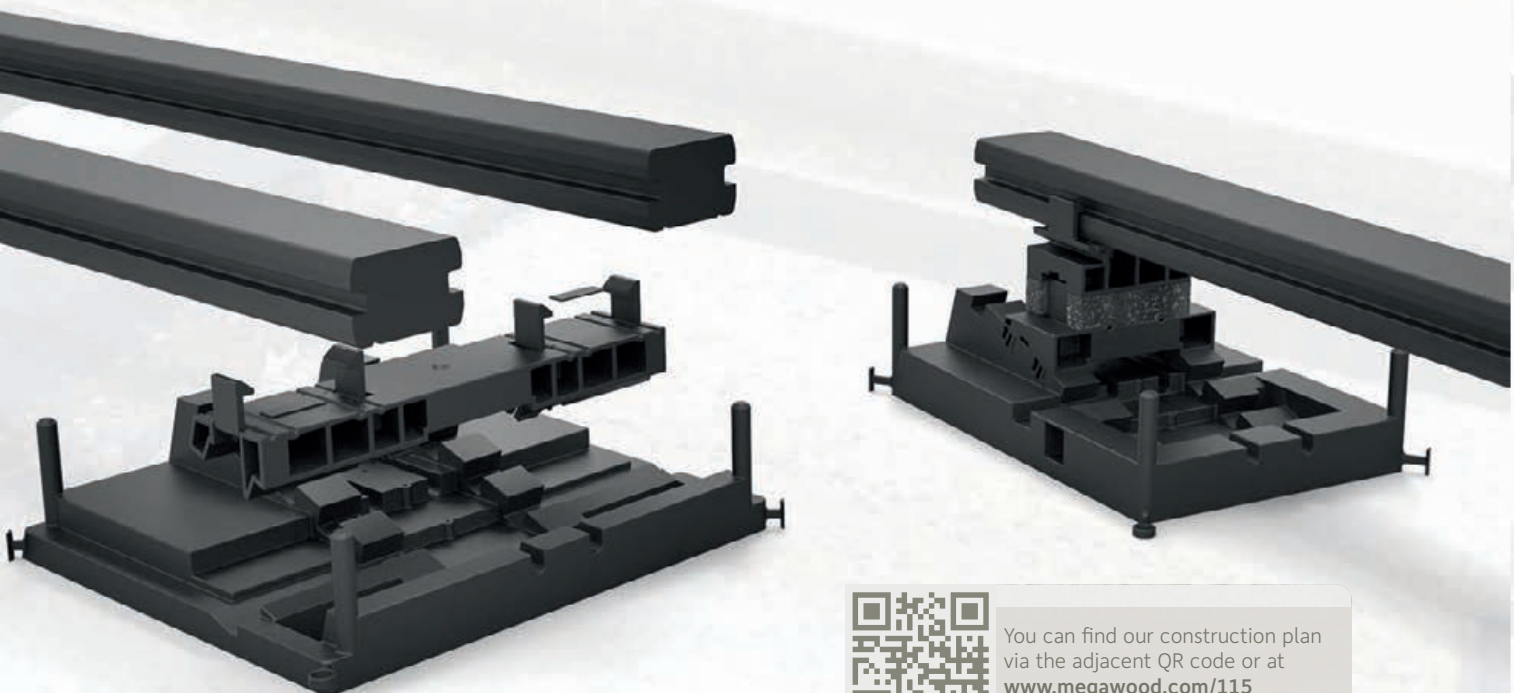

You can find our construction plan via the adjacent QR code or at [www.megawood.com/115](http://www.megawood.com/115)





Made in Germany

**megawood**



Laying  
on a gravel bed



Laying  
on an old  
patio



Floating laying style  
on roof area



# Our Decking system

## CLASSIC

### BAREFOOTBOARD

21 x 145 mm  
L: 300/360/420/  
480/540/600 cm

### 21 x 242 mm (JUMBO)

L: 420/480/600 cm

### COLOURS

NATURAL BROWN  
NUT BROWN  
BASALT GREY  
LAVA BROWN  
SLATE GREY

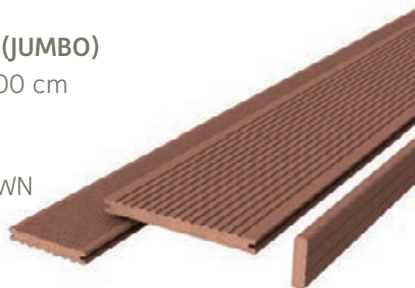

## SIGNUM

### BAREFOOTBOARD

21 x 145 mm  
L: 300/360/420/  
480/540/600 cm

### 21 x 242 mm (JUMBO)

L: 300/360/420/  
480/540/600 cm

### COLOURS

MUSKAT  
TONKA



## PREMIUM

### BAREFOOTBOARD

21 x 145 mm  
L: 300/360/420/  
480/540/600 cm

### 21 x 242 mm (JUMBO)

L: 420/480/600 cm

### COLOURS

NATURAL BROWN  
NUT BROWN  
BASALT GREY

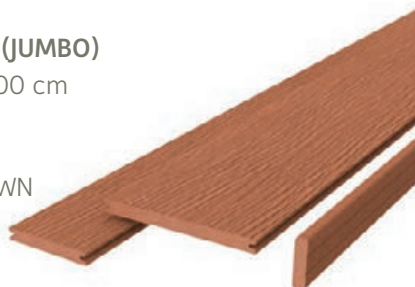

## PREMIUM PLUS

### BAREFOOTBOARD

21 x 145 mm  
L: 300/360/420/  
480/540/600 cm

### 21 x 242 mm (JUMBO)

L: 300/360/420/  
480/540/600 cm

### COLOURS

LAVA BROWN  
SLATE GREY



## FIX STEP SUB-STRUCTURE

### CONSTRUCTION BEAMS

40 x 60 mm | L: 360 cm

### FIX STEP ATTACHMENT

79 x 58 x 63 mm

### FIX STEP COMFORT PAD

For cushioning (optional)

### FIX STEP STANDARD MOUNTING

116 x 60 x 55 mm

### FIX STEP STANDARD PANEL

270 x 180 x 71 mm

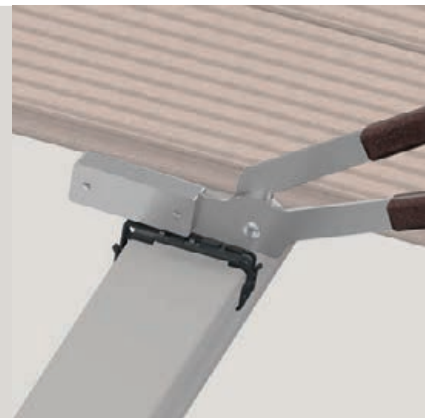

### ONE-PIECE LOCKING CLAMP

**NEW:** Making assembly easier with the „ZAMMER“, tool, see Page 20





## DYNUM

### BAREFOOTBOARD

21 x 242 mm

L: 360/420/480/  
540/600 cm

25 x 293 mm

L: 360/420/480/  
540/600 cm

### COLOURS

CARDAMOM  
NIGELLA

### SMOOTH EDGE BOARD

17 x 72 mm

L: 360 cm



### BENCH

40 x 112 mm,

Overall length: 180 cm

### COLOURS

NATURAL BROWN  
NUT BROWN  
BASALT GREY  
LAVA BROWN  
SLATE GREY



### SANDPIT

customised design, upon request

### COLOURS

LAVA BROWN  
SLATE GREY

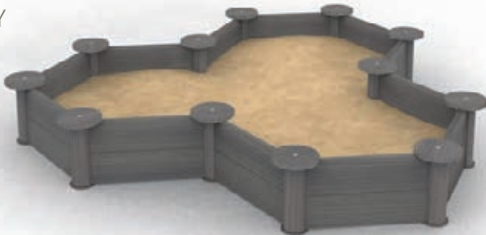

### PLANT POT

100 x 100 cm

customised dimensions upon request

### COLOURS

LAVA BROWN  
SLATE GREY



## CONCRETE EDGE STONE SUB-CONSTRUCTION

### CONSTRUCTION BEAMS

40 x 60 mm | L: 360 cm

### RUBBER PAD

60 x 100 mm

Thickness: 3/10/20mm

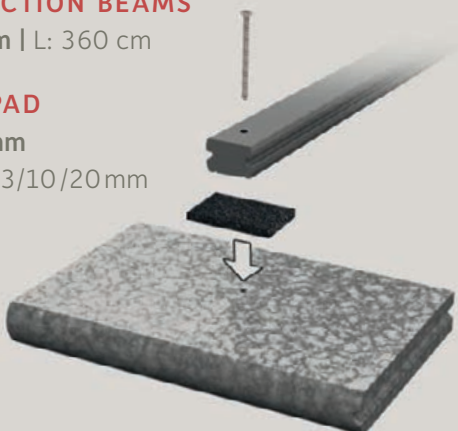

## MEGALITE

### MAXI LED FLOOR SPOTLIGHT

Ø 60 mm; H: 30 mm;

V4A stainless steel

Output/voltage: 0.9 W/12 V DC



### MINI LED FLOOR SPOTLIGHT

Ø 34 mm; H: 30 mm;

V4A stainless steel

Output/voltage: 0.4 W/12 V DC





NEW

# LIMES – as lively as your garden

The **LIMES fencing system** from the megawood® brand family emphasises the features of your garden design. The natural marbling of the fencing panels that can be **freely combined with the frame design** make the fence as lively as your garden. The wavy and smooth panels provide you with diverse combination possibilities for privacy screens and fences. The connection is created by the innovative **transom connectors** from megawood® and special panel brackets.



GINGER

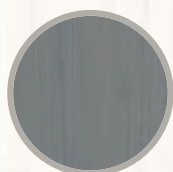

SEL GRIS

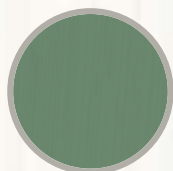

BAY LEAF

The LIMES fencing system can also be combined with acrylic or laminated safety glass for example. You can acquire these from a specialised dealer.







Made in Germany

**megawood**



**LIMES Vertical fence,**  
Lava brown frame,  
Wavy ginger panel



You will find application examples for the new LIMES fencing system by scanning the following QR code or at [www.megawood.com/126](http://www.megawood.com/126)



**NEW**

# LIMES fencing system – Assembly diversity

The diverse **post versions** that can be directly concreted into the ground, promise a high degree of stability and durability. Available in system dimensions, the fence can also be individually adapted to your garden requirements, as with all of the megawood® products. Construct at an angle, with niches, waves or gates. Our **LIMES fencing system** has no difficulties when following the terrain: parallel in an elegant form or simply stepped.

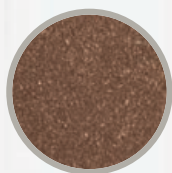

LAVA BROWN

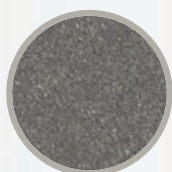

SLATE GREY



**LIMES POSTS**

Lengths 220 cm / 270 cm  
 round Ø 90 mm  
 octagonal 90 x 90 mm  
 square 90 x 90 mm  
 oval 90 x 60 mm



**LIMES HORIZONTAL FENCE  
 OVAL | SQUARE**

90 x 60 mm | 40 x 112 mm  
 Length: 178,6 cm  
 Axial dimension per field: 190 cm



**FOLLOWING THE TERRAIN  
 OBLIQUELY**



**FOLLOWING THE TERRAIN  
 STEPPED**



**ANGULAR DESIGN**





Made in Germany

**megawood**



**LIMES vertical fence,**  
Frame: slate grey,  
Panel: Sel Gris smooth



You will find the new megawood® fence configurator by scanning this QR code or at [www.megawood.com/127](http://www.megawood.com/127)



# Construction plank – our Multitalent

Stable, weatherproof and durable – the megawood® construction wood. Continue to design new creations from your megawood® products – in keeping with each of the life phases: when the children are older, the sandpit is simply converted into a raised garden bed. Discover the diverse applications and inspirations. Please adhere to all of the building regulations when doing so.

## PLANT POT

A stable plant pot is created from **construction wood** that matches the megawood® terrace.



## BENCH

### Axial dimensions:

max. 130 cm (40 x 112 mm)  
max. 160 cm (40 x 145 mm)



## SANDPIT

Ideal for small children: does not contain any dangerous splinters and is very durable. It can also be used as a raised garden bed later.



## STEPS

The megawood® **construction plank** convinces with its weather resistance and stability.



### Axial dimensions:

max. 80 cm (40 x 112 mm)  
max. 100 cm (40 x 145 mm)

## FOOTBRIDGE

The megawood® **construction plank** is the first choice even in areas that are put to heavy use. It can even be used as a footbridge board.



### Axial dimensions:

max. 100 cm (40 x 112 mm)  
max. 120 cm (40 x 145 mm)

## FENCE

Fence elements made from megawood® **construction planks** and concrete: a combination that lasts for ever.



### Clear dimensions/plank lengths:

max. 170 cm/180 cm  
(40 x 112 mm)  
max. 200 cm/210 cm  
(40 x 145 mm)





made in Germany

**megawood**

LIMES horizontal fence,  
Lava brown posts and connectors



# LIMES fencing system



## TRANSOM

OVAL | RECTANGULAR

90 x 60 mm | 40 x 112 mm

L: 178,6 cm

## COLOURS

LAVA BROWN  
SLATE GREY



## POSTS

ROUND | SQUARE | OCTAGONAL | OVAL

Ø 90 mm | 90 x 90 mm | 90 x 90 mm | 90 x 60 mm

L: 220 / 270 cm

## COLOURS

LAVA BROWN  
SLATE GREY

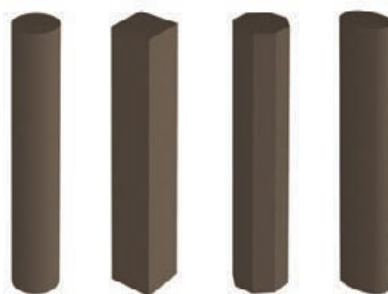

## WAVY PANEL

270 x 35 mm

L: 160,2 / 210 cm

## COLOURS

GINGER  
SEL GRIS  
BAY LEAF



## SMOOTH PANEL

239 x 6 mm

L: 158,4 / 210 cm

## COLOURS

GINGER  
SEL GRIS  
BAY LEAF



## CONNECTING SPACER

38 x 30 mm

L: 156,6 /  
178,6 / 190 cm

## COLOURS

LAVA BROWN  
SLATE GREY



## TRANSOM CONNECTOR 2-PIECE (POST/TRANSOM)

incl. screws M6 x 30

Stainless steel blackened



## PANEL BRACKET

for wavy panels

16 per field

Stainless steel



## DOOR/GATE

1.020 x 1850 mm

Frame 1.120 mm x 2.000 mm

Overall frame height: 2.700 mm

## PANEL

both panel versions are available

## CAUTION

Friction lock the frame to the post using 5 M8 x 80 screws per side and then concrete them in together.



# Construction wood



## CONSTRUCTION PLANK

40 x 112 mm / L: 360 cm

40 x 145 mm / L: 420 cm

## COLOURS

NATURAL BROWN

NUT BROWN

BASALT GREY

LAVA BROWN

SLATE GREY

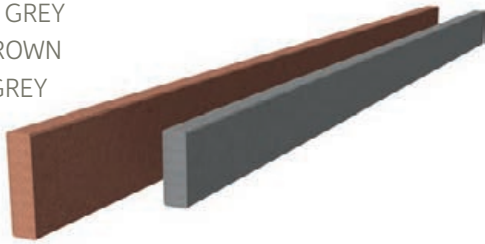

## CONSTRUCTION WOOD

ROUND | SQUARE | OCTAGONAL | OVAL

Ø 90 mm | 90 x 90 mm | 90 x 90 mm | 90 x 60 mm

L: 360 cm

## COLOURS

LAVA BROWN

SLATE GREY

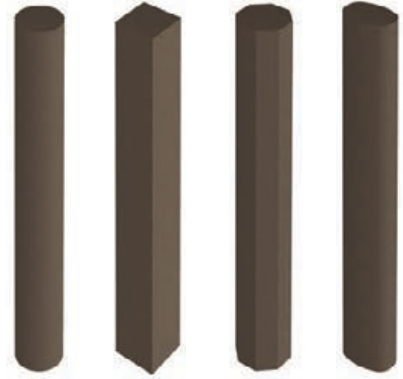

You will find application examples by scanning the QR code opposite or online at [www.megawood.com/128](http://www.megawood.com/128)

## POSTS SCREWED TO THE BASEPLATE

120 x 120 mm

incl. screws M8 x 80  
galvanized

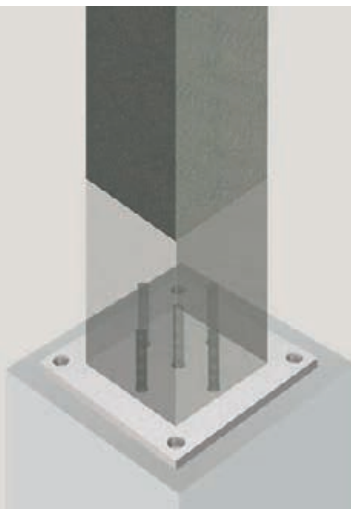

## POSTS CONCRETED IN

## 25 YEAR WARRANTY

against decaying  
in the soil







# Marker

## megaplaner<sup>3d</sup>

### INTERACTIVELY EXPERIENCE MEGAWOOD®

You can construct a virtual megawood® deck in front of your house with the megaplaner App for iOS and Android. In order to do so, simply enter the dimensions of your deck and receive your individual construction plan!

**View your new megawood® deck from all directions:** From the sub-construction to the barefootboard. Simply position this marker page at the point where you would like to build your deck, scan it with your Smartphone or tablet and experience your new deck live and in 3D.

### YOUR DEALER



You can find further useful information via the adjacent QR code or at [www.megawood.com/118](http://www.megawood.com/118)

### IMPRINT

**Publisher:** NOVO-TECH TRADING GmbH & Co. KG  
Siemensstraße 31, 06449 Ascherleben, Germany

**Text:** toolboxx-media, Stefanie Härtel

**Conception/design/layout:**  
toolboxx-media, Magdeburg, Germany

**Picture credits:** Christian Wolf, Thomas Lein, Thomas Gasparini, Thomas O. Kling, Henning Weidhase  
Subject to change. Colours and graphics may differ due to printing processes.

**Date:** 2. edition 2017 EN / 23.02.2017



4048533040335

[www.megawood.com](http://www.megawood.com)

